



December 2008

PRELIMINARY

# MMF200N120DA MMF200N120DK

1200V 200A FRED Module  
RoHS Compliant

## PRODUCT FEATURES

- Ultrafast Reverse Recovery Time
- Soft Reverse Recovery Characteristics
- Low Reverse Recovery Loss
- Low Forward Voltage
- High Surge Current Capability
- Low Inductance Package



## APPLICATIONS

- Inversion Welder
- Uninterruptible Power Supply (UPS)
- Plating Power Supply
- Ultrasonic Cleaner and Welder
- Converter & Chopper
- Power Factor Correction (PFC) Circuit

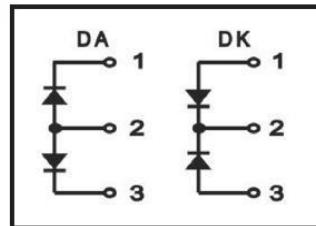

## ABSOLUTE MAXIMUM RATINGS

$T_C=25^{\circ}\text{C}$  unless otherwise specified

Symbol	Parameter	Test Conditions	Values	Unit
$V_R$	Maximum D.C. Reverse Voltage		1200	V
$V_{RRM}$	Maximum Repetitive Reverse Voltage		1200	V
$I_{F(AV)}$	Average Forward Current	$T_C=75^{\circ}\text{C}$ , Per Diode	100	A
		$T_C=75^{\circ}\text{C}$ , Per Moudle	200	A
		$T_C=85^{\circ}\text{C}$ , 20KHz, Per Moudle	150	A
$I_{F(RMS)}$	RMS Forward Current	$T_C=75^{\circ}\text{C}$ , Per Diode	150	A
$I_{FSM}$	Non-Repetitive Surge Forward Current	$T_J=45^{\circ}\text{C}$ , $t=10\text{ms}$ , 50Hz, Sine	1100	A
		$T_J=45^{\circ}\text{C}$ , $t=8.3\text{ms}$ , 60Hz, Sine	1200	A
$I^2t$	$I^2t$ (For Fusing)	$T_J=45^{\circ}\text{C}$ , $t=10\text{ms}$ , 50Hz, Sine	6050	$\text{A}^2\text{s}$
		$T_J=45^{\circ}\text{C}$ , $t=8.3\text{ms}$ , 60Hz, Sine	7200	$\text{A}^2\text{s}$
$P_D$	Power Dissipation		280	W
$T_J$	Junction Temperature		-40 to +150	$^{\circ}\text{C}$
$T_{STG}$	Storage Temperature Range		-40 to +125	$^{\circ}\text{C}$
$V_{ISOL}$	Insulation Test Voltage	AC, $t=1\text{min}$	3000	V
Torque	Module-to-Sink	Recommended (M5)	2.5~4	N·m
Torque	Module Electrodes	Recommended (M5)	2.5~4	N·m
$R_{\theta JC}$	Thermal Resistance	Junction-to-Case	0.44	$^{\circ}\text{C}/\text{W}$
Weight			100	g

MacMic Science & Technology Co., Ltd.

Add: #18, Hua Shan Zhong Lu, New District, Changzhou City, Jiangsu Province, P. R .of China

Tel.: +86-519-85163708 Fax: +86-519-85162291 Post Code: 213022 Website: [www.macmicst.com](http://www.macmicst.com)

**ELECTRICAL CHARACTERISTICS**

$T_C=25^\circ\text{C}$  unless otherwise specified

Symbol	Parameter	Test Conditions	Min.	Typ.	Max.	Unit
$I_{RM}$	Reverse Leakage Current	$V_R=1200\text{V}$	--	--	1	mA
		$V_R=1200\text{V}, T_J=125^\circ\text{C}$	--	--	20	mA
$V_F$	Forward Voltage	$I_F=100\text{A}$	--	--	1.77	V
		$I_F=100\text{A}, T_J=125^\circ\text{C}$	--	--	1.6	V
$t_{rr}$	Reverse Recovery Time	$I_F=1\text{A}, V_R=30\text{V}, di_F/dt=-200\text{A}/\mu\text{s}$	--	35	--	ns
$t_{rr}$	Reverse Recovery Time	$V_R=600\text{V}, I_F=100\text{A}$	--	150	--	ns
$I_{RRM}$	Max. Reverse Recovery Current		$di_F/dt=-200\text{A}/\mu\text{s}, T_J=25^\circ\text{C}$	--	28	--
$t_{rr}$	Reverse Recovery Time	$V_R=600\text{V}, I_F=100\text{A}$	--	250	--	ns
$I_{RRM}$	Max. Reverse Recovery Current		$di_F/dt=-200\text{A}/\mu\text{s}, T_J=100^\circ\text{C}$	--	47	--

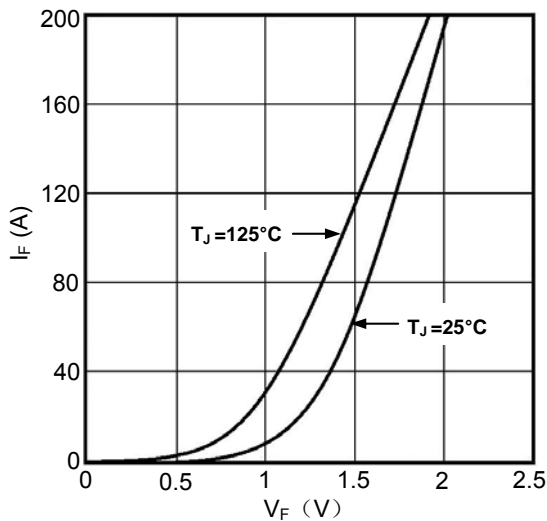

Figure1. Forward Voltage Drop vs Forward Current

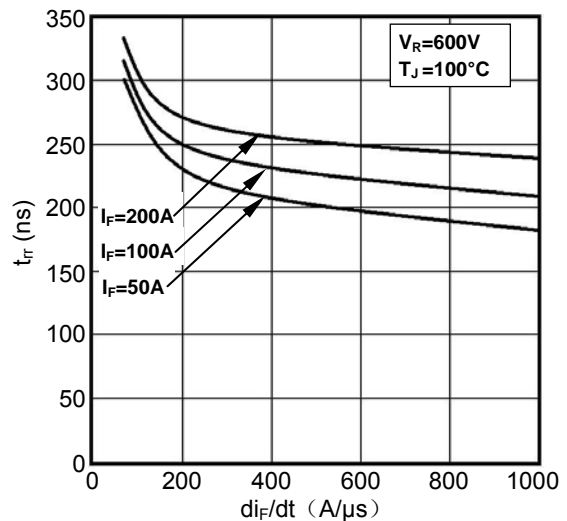

Figure2. Reverse Recovery Time vs  $di_F/dt$

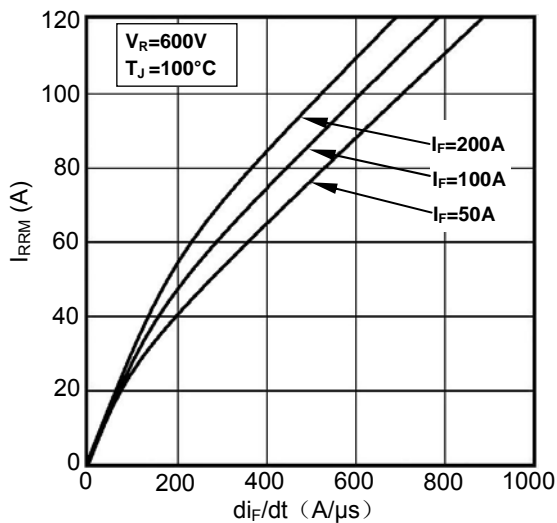

Figure3. Reverse Recovery Current vs  $di_F/dt$

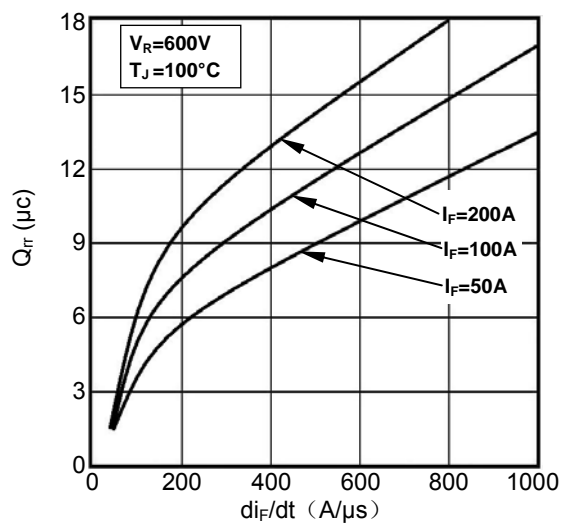

Figure4. Reverse Recovery Charge vs  $di_F/dt$

**MMF200N120DA  
MMF200N120DK**

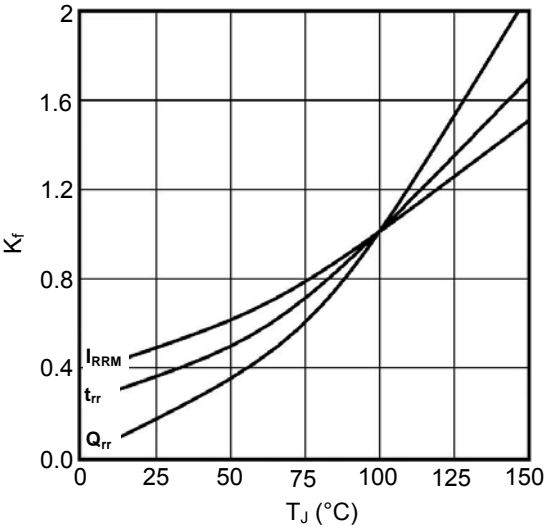

Figure5. Dynamic Parameters vs Junction Temperature

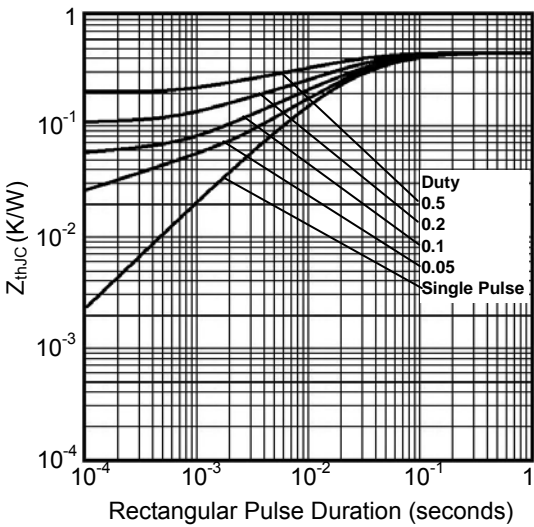
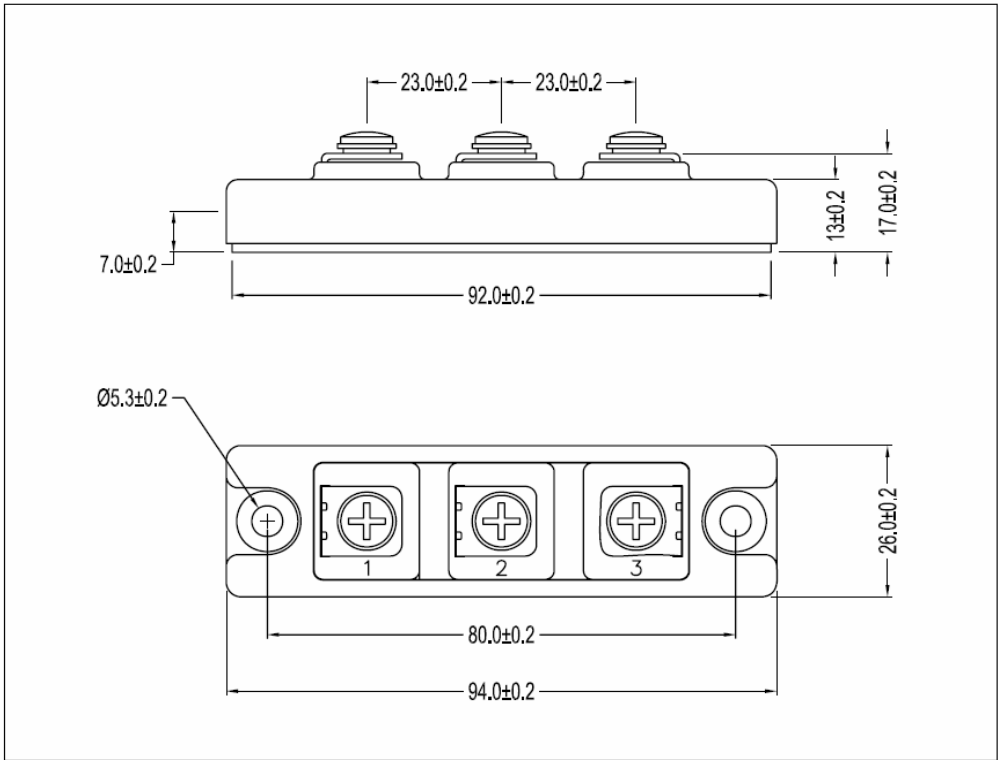

Figure6. Transient Thermal Impedance



Dimensions (mm)  
Figure7. Package Outline