

## Features

- Isolated Module Package
- Isolation voltage 3000 V
- Three Phase Bridge and a Thyristor

## Applications

- Current Stabilized Power Supply
- Switching Power Supply
- Inverter For AC or DC Motor Control

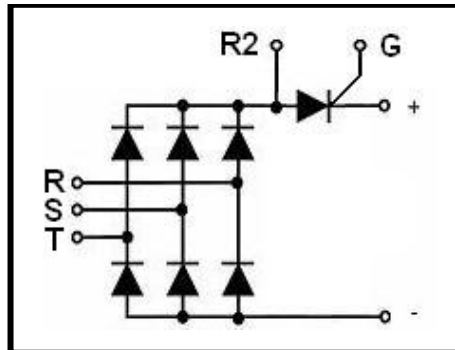

## ■ Diode

### ABSOLUTE MAXIMUM RATINGS

$T_C=25^{\circ}\text{C}$  unless otherwise specified

Symbol	Parameter	Test Conditions	Max.	Unit
$V_{RRM}$	Repetitive Reverse Voltage		1600	V
$I_{D(AV)}$	Average Forward Current	$T_C=90^{\circ}\text{C}$ , module	100	A
$I_{FSM}$	Non-Repetitive Surge Forward Current	$T_J=45^{\circ}\text{C}$ , $t=10\text{ms}$ , 50Hz, Sine	1250	A
		$T_J=45^{\circ}\text{C}$ , $t=8.3\text{ms}$ , 60Hz, Sine	1350	A
$I^2t$	$I^2t$ (For Fusing)	$T_J=45^{\circ}\text{C}$ , $t=10\text{ms}$ , 50Hz, Sine	7.8	$\text{kA}^2\text{s}$
		$T_J=45^{\circ}\text{C}$ , $t=8.3\text{ms}$ , 60Hz, Sine	7.5	$\text{kA}^2\text{s}$
$T_J$	Junction Temperature		-40 to +150	$^{\circ}\text{C}$
$T_{STG}$	Storage Temperature Range		-40 to +125	$^{\circ}\text{C}$
$V_{isol}$	Insulation Test Voltage	AC, 50Hz, $t=1\text{min}$	3000	V
Weight			332	g

### ELECTRICAL AND THERMAL CHARACTERISTICS

$T_C=25^{\circ}\text{C}$  unless otherwise specified

Symbol	Parameter	Test Conditions	Min.	Typ.	Max.	Unit
$I_{RM}$	Reverse Leakage Current	$V_R=1600\text{V}$	--	--	500	$\mu\text{A}$
		$V_R=1600\text{V}$ , $T_J=125^{\circ}\text{C}$	--	--	5	mA
$V_F$	Forward Voltage	$I_F=100\text{A}$	--	1.15	--	V
		$I_F=100\text{A}$ , $T_J=125^{\circ}\text{C}$	--	1.1	--	V
$R_{\theta JC}$	Thermal Resistance Junction-to-Case	per diode	--	--	0.84	$^{\circ}\text{C}/\text{W}$
		per module	--	--	0.14	$^{\circ}\text{C}/\text{W}$
$R_{\theta CS}$	Thermal Resistance Case -to-Sink	per diode	--	--	0.39	$^{\circ}\text{C}/\text{W}$
		per module	--	--	0.065	$^{\circ}\text{C}/\text{W}$

## ■ Thyristor

### ABSOLUTE MAXIMUM RATINGS

$T_C=25^\circ\text{C}$  unless otherwise specified

Symbol	Test Condition	Value	Unit
$V_{RRM}$		1600	V
$I_{T(AV)}$	$T_C=90^\circ\text{C}$ , 180° conduction, half sine wave;	100	A
$I_{TSM}$	$T_J=45^\circ\text{C}$ , $t=10\text{ms}$ (50Hz), sine, $V_R=V_{RRM}$ ;	1550	A
	$T_J=45^\circ\text{C}$ , $t=8.3\text{ms}$ (60Hz), sine, $V_R=V_{RRM}$ ;	1650	
$I^2t$	$T_J=45^\circ\text{C}$ , $t=10\text{ms}$ (50Hz), sine, $V_R=V_{RRM}$ ;	12.0	$\text{kA}^2\text{s}$
	$T_J=45^\circ\text{C}$ , $t=8.3\text{ms}$ (60Hz), sine, $V_R=V_{RRM}$ ;	11.3	
$dV/dt$	$T_J=125^\circ\text{C}$ , exponential to 67% rated $V_{DRM}$	1000	V/us
$dI/dt$	$T_J=125^\circ\text{C}$ , $I_{TM}=300\text{A}$ rated $V_{DRM}$	150	A/us
$V_{ISOL}$	50Hz, all terminals shorted, $t=1\text{s}$ , $I_{ISOL}\leq 1\text{mA}$ ;	3000	V~
$T_J$	Max. junction operating temperature range	-40~125	$^\circ\text{C}$
$T_{STG}$	Max. storage temperature range	-40~125	$^\circ\text{C}$
	Mounting torque(M6)	3 to 5	N·m
	Terminal connection torque(M6)	3 to 5	N·m
	Terminal connection torque(M4)	1 to 2	N·m

### ELECTRICAL AND THERMAL CHARACTERISTICS

$T_C=25^\circ\text{C}$  unless otherwise specified

Symbol	Test Condition	Min.	Typ.	Max.	Unit
$I_{DRM}/I_{RRM}$	$T_J=125^\circ\text{C}$ , $V_D=V_R=1600\text{V}$ ;			20	mA
$V_{TM}$	$I_{TM}=314\text{A}$ , $t_d=10\text{ms}$ , half sine;		1.54		V
$V_{GT}$	$V_A=6\text{V}$ , $R_A=1\Omega$ , $T_J=-40^\circ\text{C}$ ;			4	V
	$V_A=6\text{V}$ , $R_A=1\Omega$ ;			2.5	
	$V_A=6\text{V}$ , $R_A=1\Omega$ , $T_J=125^\circ\text{C}$ ;			1.7	
$I_{GT}$	$V_A=6\text{V}$ , $R_A=1\Omega$ , $T_J=-40^\circ\text{C}$ ;			200	mA
	$V_A=6\text{V}$ , $R_A=1\Omega$ ;			150	
	$V_A=6\text{V}$ , $R_A=1\Omega$ , $T_J=125^\circ\text{C}$ ;			80	
$P_{GM}$	$t_p\leq 5\text{ms}$ , $T_J=125^\circ\text{C}$ ;			12	W
$P_{GM(AV)}$	$f=50\text{Hz}$ , $T_J=125^\circ\text{C}$ ;			3	W
$R_{thjc}$	Thermal Resistance , Junction-to-Case			0.24	K/W
$R_{THCS}$	Thermal Resistance, Case -to-Sink			0.12	K/W

Characteristic curves

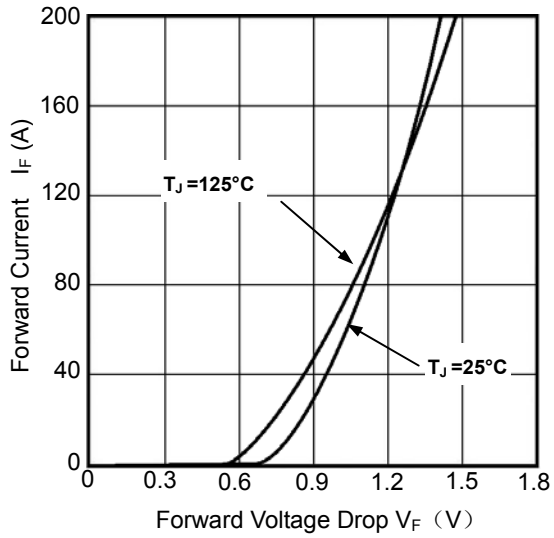

Figure 1. Diode Forward Voltage Drop vs Forward Current

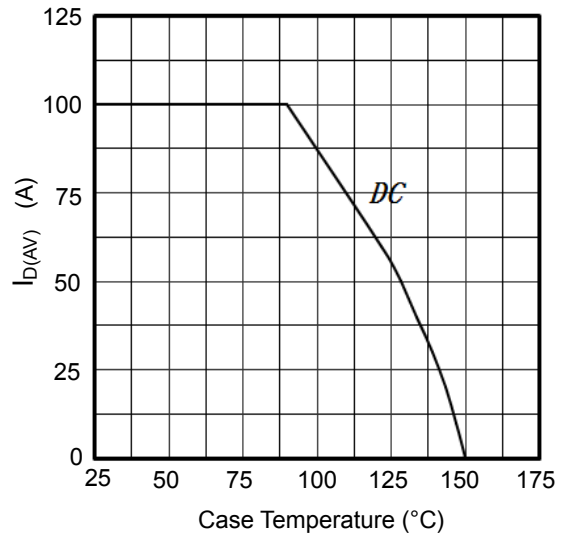

Figure 2. Diode  $I_{D(AV)}$  vs Case Temperature

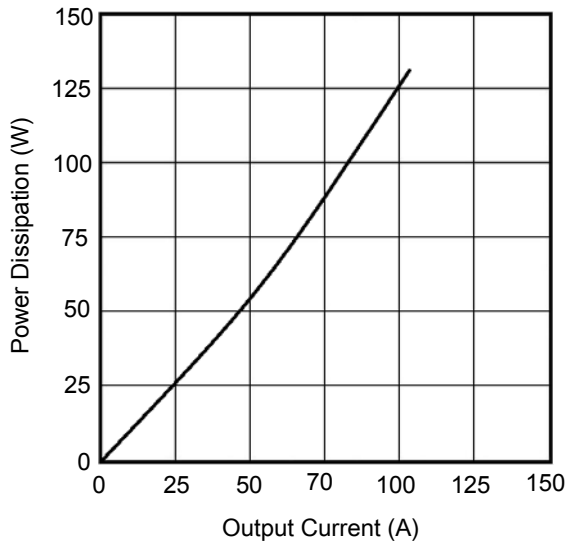

Figure 3. SCR Output Current vs Power Dissipation

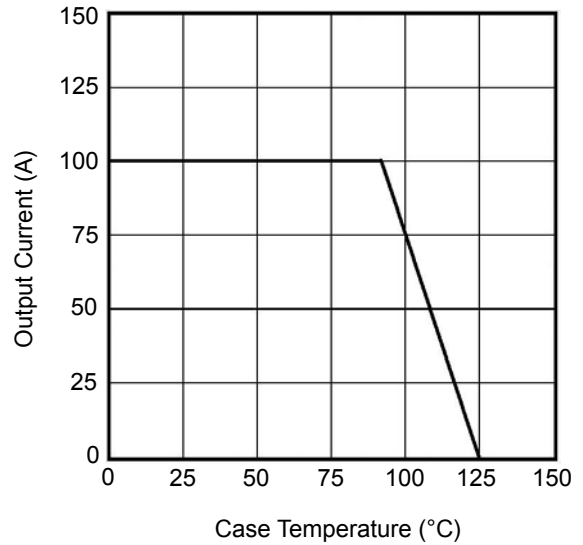

Figure 4. SCR Output Current vs Case Temperature

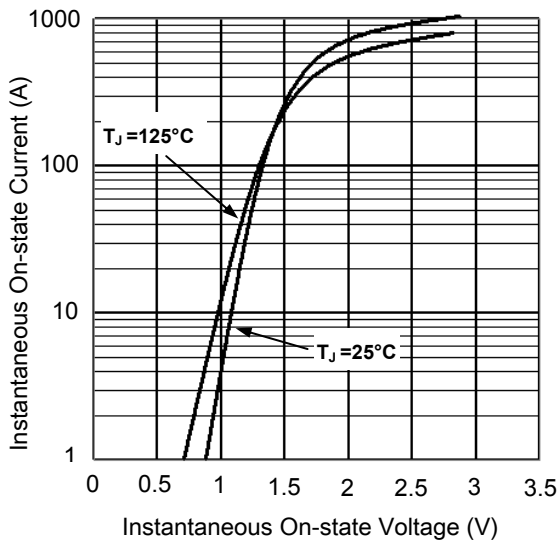

Figure 5. SCR On State Voltage Drop

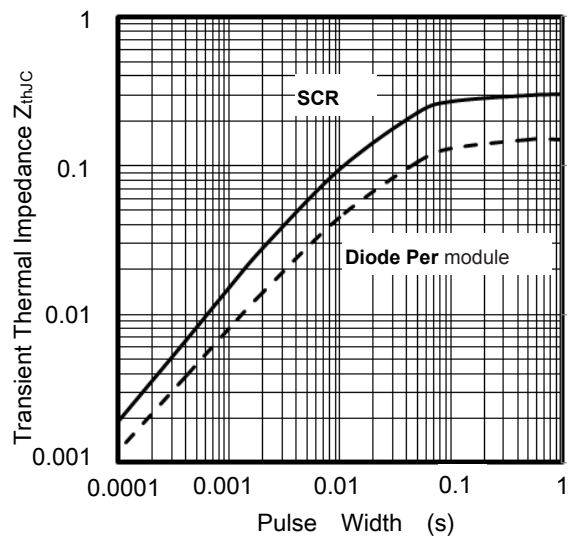

Figure 6. Diode and SCR Thermal Impedance  $Z_{thJC}$

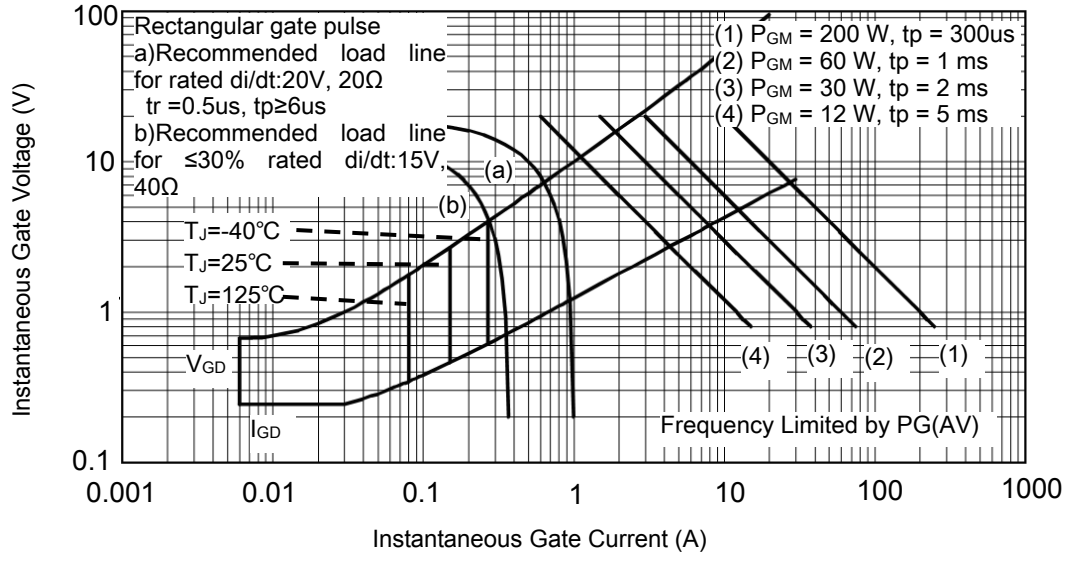

Figure 7. Gate Characteristics

Package Outline (Dimensions in mm)

