

## PRODUCT FEATURES

- Low Forward Voltage
- High Surge Current Capability
- Low Leakage Current
- Low Inductance Package

## APPLICATIONS

- Field Supply For DC Motors
- Line Rectifiers For Transistorized AC Motor Controllers
- Non-controllable Rectifiers For AC/DC Converter

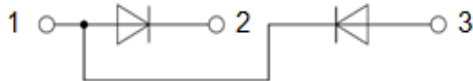

## Module Type

Module Type	Circuit Diagram	$V_{RRM}$ (Repetitive Peak Reverse Voltage)	$V_{RSM}$ (Non-Repetitive Peak Reverse Voltage)	Unit
	B			
MMD130A180B		1800	1900	V

## ABSOLUTE MAXIMUM RATINGS ( $T_C = 25^\circ\text{C}$ unless otherwise specified)

Symbol	Parameter/Test Conditions		Values	Unit
$I_{F(AV)}$	Average Forward Current	Single phase, half wave, 180° conduction, $T_C = 95^\circ\text{C}$	130	A
$I_{F(RMS)}$	R.M.S. Forward Current		204	
$I_{FSM}$	Non-Repetitive Surge Forward Current	1/2 cycle, 50HZ, peak value, $T_J = 45^\circ\text{C}$	3500	
		1/2 cycle, 60HZ, peak value, $T_J = 45^\circ\text{C}$	3800	
$I^2t$	For Fusing	1/2 cycle, 50HZ, peak value, $T_J = 45^\circ\text{C}$	61.2	KA <sup>2</sup> S
		1/2 cycle, 60HZ, peak value, $T_J = 45^\circ\text{C}$	60	
$P_D$	Power Dissipation		625	W
$T_J$	Junction Temperature		-40 to +150	$^\circ\text{C}$
$T_{STG}$	Storage Temperature Range		-40 to +125	$^\circ\text{C}$
$V_{ISO}$	Isolation Breakdown Voltage	AC, 50Hz(R.M.S), t=1minute	3000	V
Torque	Module to Sink	Recommended (M6)	3~5	Nm
Torque	Module Electrodes	Recommended (M5)	2.5~5	Nm
$R_{thJC}$	Junction to Case Thermal Resistance(per diode)		0.2	K/W
Weight			110	g

MacMic Science & Technology Co., Ltd.

Add: #18, Hua Shan Zhong Lu, New District, Changzhou City, Jiangsu Province, P. R. of China

Tel.: +86-519-85163708 Fax: +86-519-85162291 Post Code: 213022 Website: www.macmicst.com

# MMD130A180B

## ELECTRICAL CHARACTERISTICS ( $T_C=25^\circ\text{C}$ unless otherwise specified)

Symbol	Parameter/Test Conditions	Min.	Typ.	Max.	Unit
$I_{RM}$	Maximum Reverse Leakage Current	$V_R = V_{RRM}$		0.5	mA
		$V_R = V_{RRM}, T_J = 125^\circ\text{C}$		10	
$V_F$	Forward Voltage Drop			1.5	V
$V_{TO}$	For power loss calculations only, $T_J = 125^\circ\text{C}$			0.85	V
$r_T$				1.6	m $\Omega$

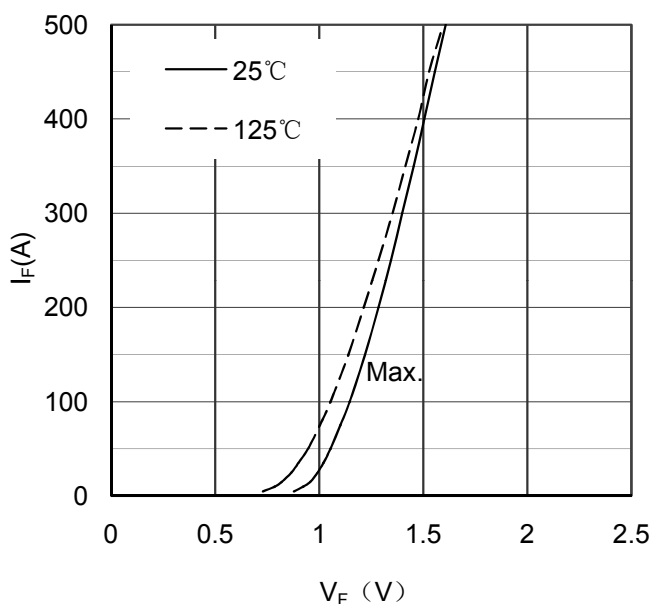

Figure 1. Forward Voltage Drop vs Forward Current

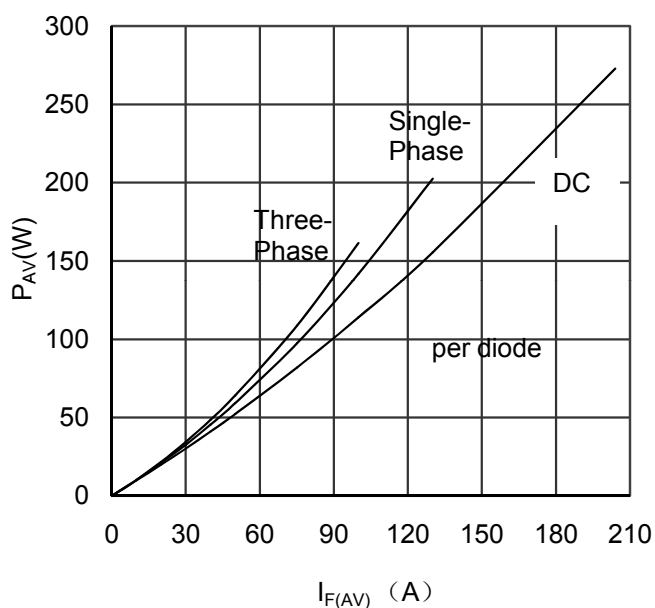

Figure 2. Power dissipation vs  $I_{F(AV)}$

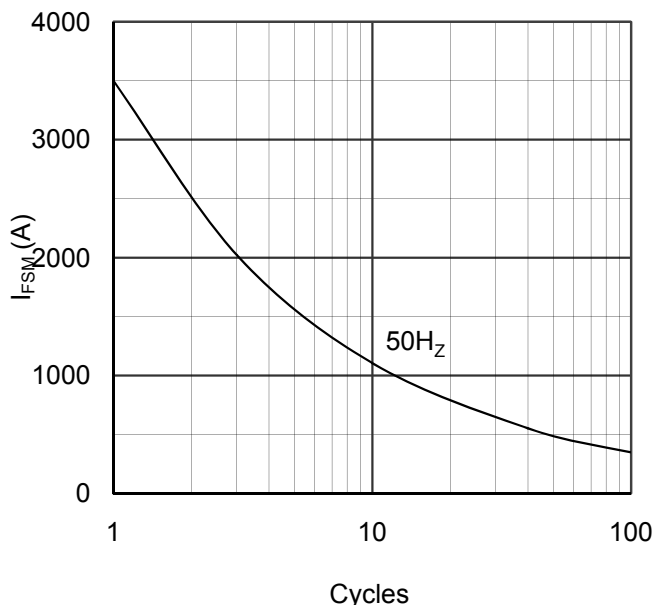

Figure 3. Max Non-Repetitive Forward Surge Current

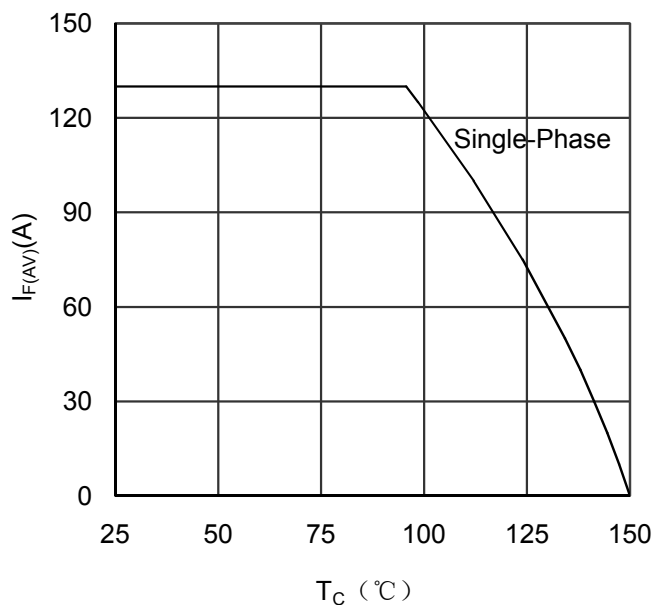

Figure 4. Average Forward Current vs Case temperature

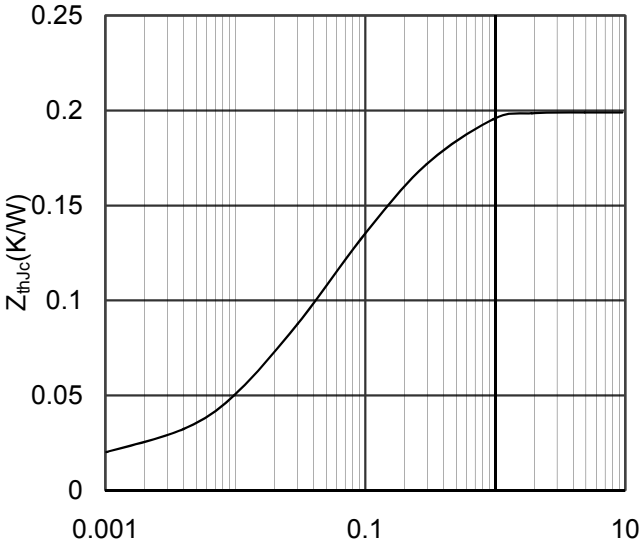
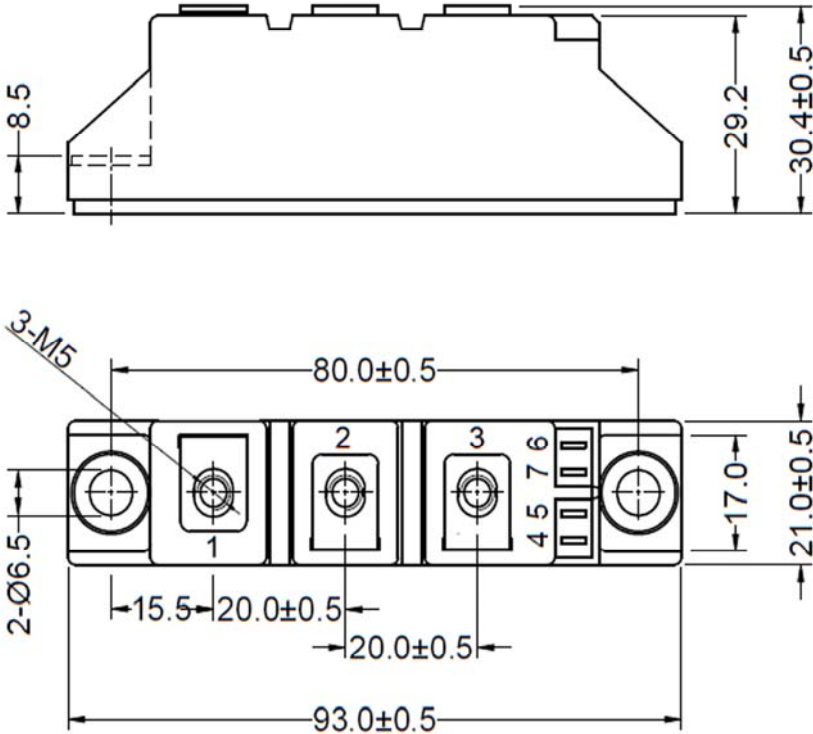

Figure 5. Transient Thermal Impedance



Dimensions in (mm)

Figure 6. Package Outline