

PRODUCT FEATURES

- 650V IGBT³ CHIP(Trench+Field Stop technology)
- Low saturation voltage and positive temperature coefficient
- Low switching losses and short tail current
- Free wheeling diodes with fast and soft reverse recovery
- Temperature sense included



APPLICATIONS

- 3-Level-Applications
- Solar Applications
- UPS Systems

IGBT(T1、 T2、 T3、 T4)

ABSOLUTE MAXIMUM RATINGS($T_C=25^\circ\text{C}$ unless otherwise specified)

Symbol	Parameter/Test Conditions		Values	Unit
V_{CES}	Collector Emitter Voltage	$T_J=25^\circ\text{C}$	650	V
V_{GES}	Gate Emitter Voltage		± 20	
I_C	DC Collector Current	$T_C=25^\circ\text{C}, T_{Jmax}=175^\circ\text{C}$	235	A
		$T_C=60^\circ\text{C}, T_{Jmax}=175^\circ\text{C}$	200	
I_{CM}	Repetitive Peak Collector Current	$t_p=1\text{ms}$	400	
P_{tot}	Power Dissipation Per IGBT	$T_C=25^\circ\text{C}, T_{Jmax}=175^\circ\text{C}$	600	W

Diode(D1~D6) ABSOLUTE MAXIMUM RATINGS ($T_C=25^\circ\text{C}$ unless otherwise specified)

Symbol	Parameter/Test Conditions		Values	Unit
V_{RRM}	Repetitive Reverse Voltage	$T_J=25^\circ\text{C}$	650	V
$I_{F(AV)}$	Average Forward Current(D1~D4)		150	A
I_{FRM}	Repetitive Peak Forward Current(D1~D4)	$t_p=1\text{ms}$	300	
I^2t	(D1~D4)	$T_J=125^\circ\text{C}, t=10\text{ms}, V_R=0\text{V}$	1450	A^2S
$I_{F(AV)}$	Average Forward Current(D5、 D6)		200	A
I_{FRM}	Repetitive Peak Forward Current(D5、 D6)	$t_p=1\text{ms}$	400	
I^2t	(D5、 D6)	$T_J=125^\circ\text{C}, t=10\text{ms}, V_R=0\text{V}$	2650	A^2S

MacMic Science & Technology Co., Ltd.

Add: #18, Hua Shan Zhong Lu, New District, Changzhou City, Jiangsu Province, P. R .of China

MMG200B065PD6EN

IGBT(T1、T2、T3、T4)

ELECTRICAL CHARACTERISTICS ($T_C=25^\circ\text{C}$ unless otherwise specified)

Symbol	Parameter/Test Conditions		Min.	Typ.	Max.	Unit
$V_{GE(th)}$	Gate Emitter Threshold Voltage	$V_{CE}=V_{GE}, I_C=3.2\text{mA}$	4.9	5.8	6.5	V
$V_{CE(sat)}$	Collector Emitter Saturation Voltage	$I_C=200\text{A}, V_{GE}=15\text{V}, T_J=25^\circ\text{C}$		1.45	1.9	
		$I_C=200\text{A}, V_{GE}=15\text{V}, T_J=150^\circ\text{C}$		1.7		
I_{CES}	Collector Leakage Current	$V_{CE}=650\text{V}, V_{GE}=0\text{V}, T_J=25^\circ\text{C}$			1	mA
		$V_{CE}=650\text{V}, V_{GE}=0\text{V}, T_J=150^\circ\text{C}$			5	
I_{GES}	Gate Leakage Current	$V_{CE}=0\text{V}, V_{GE}=\pm 15\text{V}, T_J=25^\circ\text{C}$	-400		400	nA
R_{gint}	Integrated Gate Resistor			2		Ω
Q_g	Gate Charge	$V_{CE}=300\text{V}, I_C=200\text{A}, V_{GE}=\pm 15\text{V}$		2.15		μC
C_{ies}	Input Capacitance	$V_{CE}=25\text{V}, V_{GE}=0\text{V}, f=1\text{MHz}$		12.4		nF
C_{res}	Reverse Transfer Capacitance				0.37	
$t_{d(on)}$	Turn on Delay Time	$V_{CC}=300\text{V}, I_C=200\text{A}$ $R_G=2.7\Omega,$ $V_{GE}=\pm 15\text{V},$ Inductive Load	$T_J=25^\circ\text{C}$	90		ns
			$T_J=150^\circ\text{C}$	110		ns
t_r	Rise Time	$V_{GE}=\pm 15\text{V},$ Inductive Load	$T_J=25^\circ\text{C}$	60		ns
			$T_J=150^\circ\text{C}$	60		ns
$t_{d(off)}$	Turn off Delay Time	$V_{CC}=300\text{V}, I_C=200\text{A}$ $R_G=2.7\Omega,$ $V_{GE}=\pm 15\text{V},$ Inductive Load	$T_J=25^\circ\text{C}$	390		ns
			$T_J=150^\circ\text{C}$	420		ns
t_f	Fall Time	$V_{GE}=\pm 15\text{V},$ Inductive Load	$T_J=25^\circ\text{C}$	60		ns
			$T_J=150^\circ\text{C}$	80		ns
E_{on}	Turn on Energy	$V_{CC}=300\text{V}, I_C=200\text{A}$ $R_G=2.7\Omega,$ $V_{GE}=\pm 15\text{V},$ Inductive Load	$T_J=25^\circ\text{C}$	2.5		mJ
			$T_J=150^\circ\text{C}$	3.1		mJ
E_{off}	Turn off Energy	$V_{GE}=\pm 15\text{V},$ Inductive Load	$T_J=25^\circ\text{C}$	5.5		mJ
			$T_J=150^\circ\text{C}$	7.1		mJ
I_{SC}	Short Circuit Current	$tp_{sc}\leq 6\mu\text{S}, V_{GE}=15\text{V}$ $T_J=125^\circ\text{C}, V_{CC}=360\text{V}$		1000		A
R_{thJC}	Junction to Case Thermal Resistance (Per IGBT)				0.25	K /W

Diode(D1~D6) ELECTRICAL CHARACTERISTICS ($T_C=25^\circ\text{C}$ unless otherwise specified)

Symbol	Parameter/Test Conditions		Min.	Typ.	Max.	Unit
V_F	Forward Voltage(D1~D4)	$I_F=150\text{A}, V_{GE}=0\text{V}, T_J=25^\circ\text{C}$		1.55	1.95	V
		$I_F=150\text{A}, V_{GE}=0\text{V}, T_J=150^\circ\text{C}$		1.45		
t_{rr}	Reverse Recovery Time(D1~D4)	$I_F=150\text{A}, V_R=300\text{V}$ $di_F/dt=-1700\text{A}/\mu\text{s}$ $T_J=150^\circ\text{C}$		130		ns
I_{RRM}	Max. Reverse Recovery Current(D1~D4)			80		A
Q_{RR}	Reverse Recovery Charge(D1~D4)			13		μC
E_{rec}	Reverse Recovery Energy(D1~D4)			3.5		mJ
R_{thJCD}	Junction to Case Thermal Resistance (Per Diode) (D1~D4)				0.6	K /W
V_F	Forward Voltage(D5、D6)	$I_F=200\text{A}, V_{GE}=0\text{V}, T_J=25^\circ\text{C}$		1.55	1.95	V
		$I_F=200\text{A}, V_{GE}=0\text{V}, T_J=150^\circ\text{C}$		1.45		
t_{rr}	Reverse Recovery Time(D5、D6)	$I_F=200\text{A}, V_R=300\text{V}$ $di_F/dt=-2300\text{A}/\mu\text{s}$ $T_J=150^\circ\text{C}$		135		ns
I_{RRM}	Max. Reverse Recovery Current(D5、D6)			148		A
Q_{RR}	Reverse Recovery Charge(D5、D6)			20		μC
E_{rec}	Reverse Recovery Energy(D5、D6)			5		mJ
R_{thJCD}	Junction to Case Thermal Resistance (Per Diode) (D5、D6)				0.45	K /W

MMG200B065PD6EN

NTC CHARACTERISTICS ($T_C=25^\circ\text{C}$ unless otherwise specified)

Symbol	Parameter/Test Conditions	Min.	Typ.	Max.	Unit
R_{25}	Resistance $T_C=25^\circ\text{C}$		5		K Ω
$B_{25/50}$	$R_2 = R_{25} \exp [B_{25/50}(1/T_2 - 1/(298.15 \text{ K}))]$		3375		K

MODULE CHARACTERISTICS ($T_C=25^\circ\text{C}$ unless otherwise specified)

Symbol	Parameter/Test Conditions	Values	Unit	
T_{Jmax}	Max. Junction Temperature	175	°C	
T_{Jop}	Operating Temperature	-40~150		
T_{stg}	Storage Temperature	-40~125		
V_{isol}	Isolation Breakdown Voltage	AC, 50Hz(R.M.S), t=1minute	3000	V
CTI	Comparative Tracking Index		> 200	
Torque	to heatsink	Recommended (M6)	3~5	Nm
	to terminal	Recommended (M6)	3~5	Nm
Weight			300	g

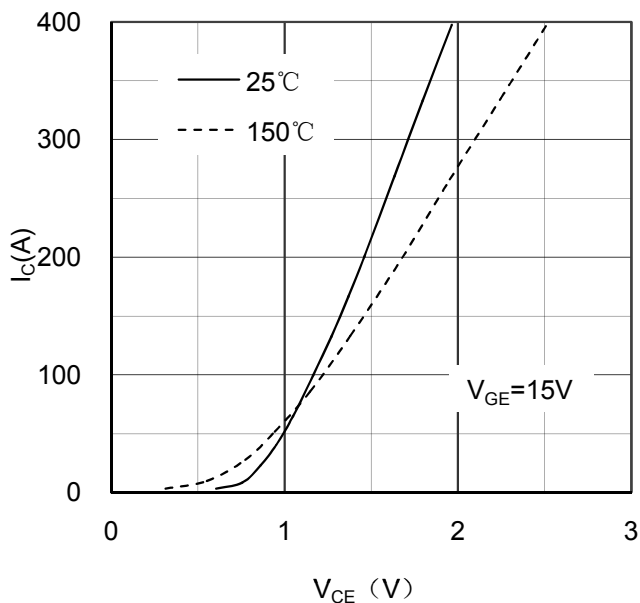

Figure 1. Typical Output Characteristics IGBT

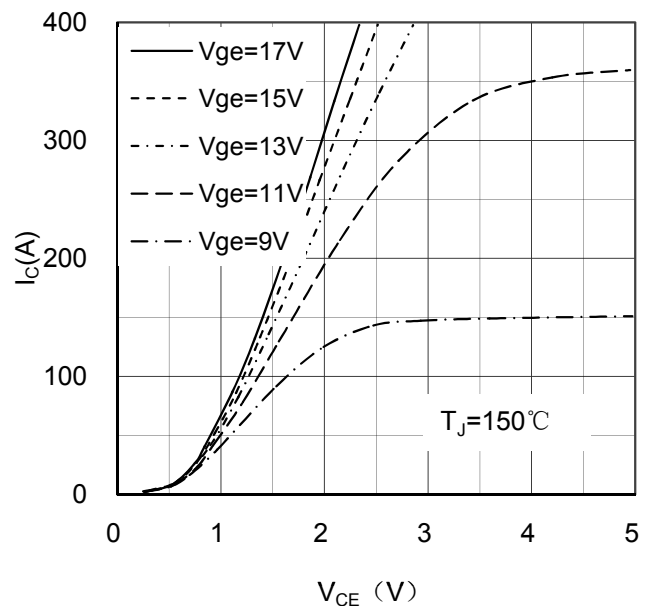

Figure 2. Typical Output Characteristics IGBT

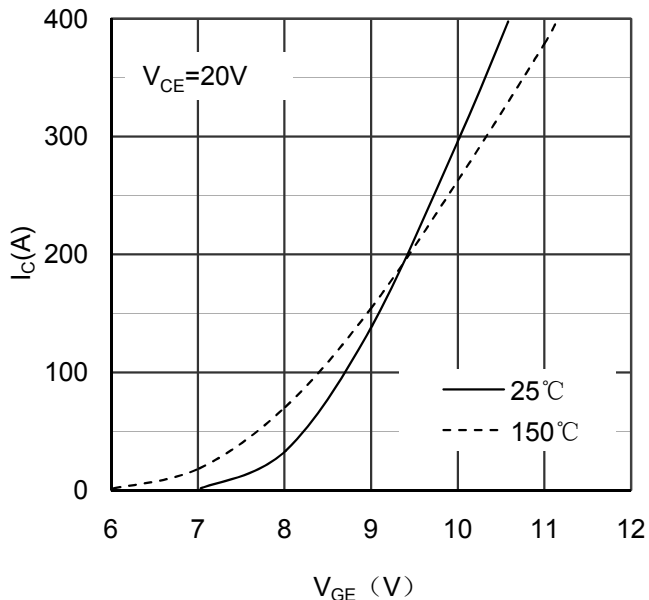

Figure 3. Typical Transfer characteristics IGBT

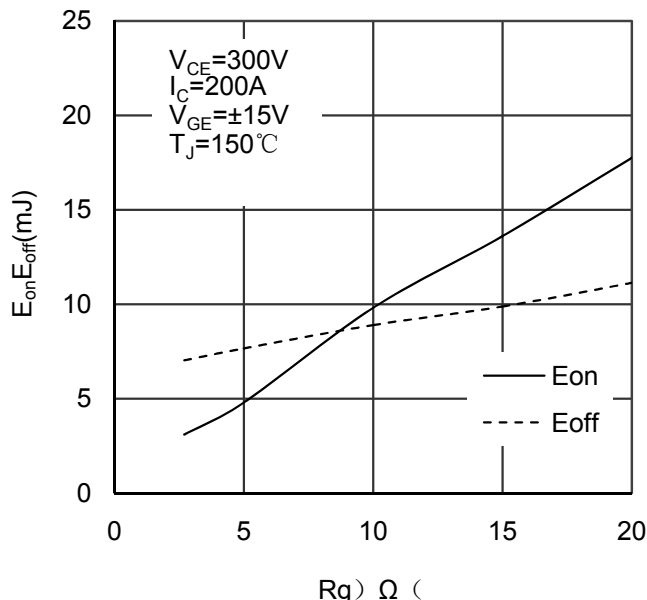

Figure 4. Switching Energy vs Gate Resistor IGBT

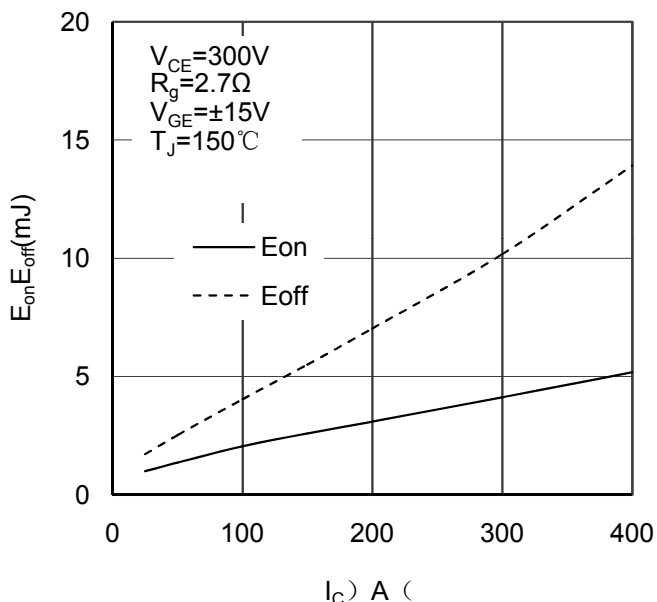

Figure 5. Switching Energy vs Collector Current IGBT

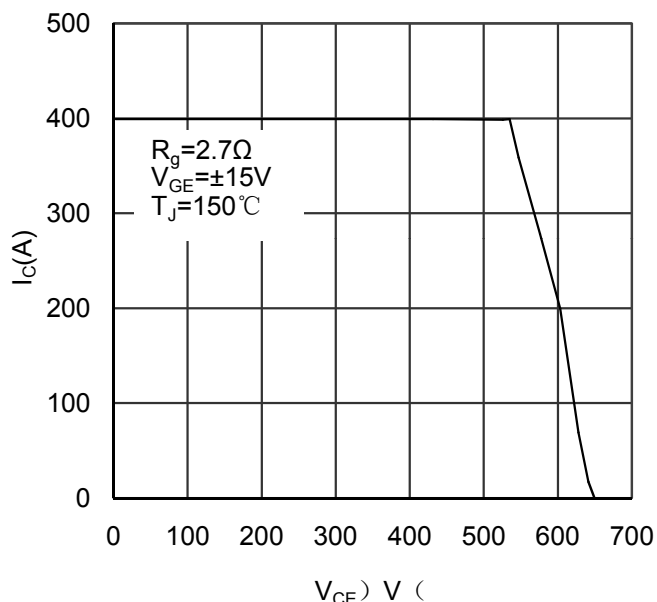

Figure 6. Reverse Biased Safe Operating Area IGBT

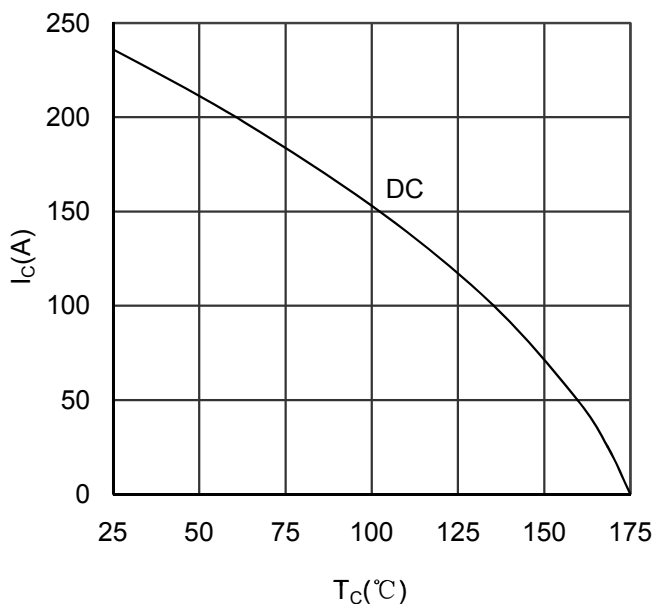

Figure 7. Collector Current vs Case temperature IGBT

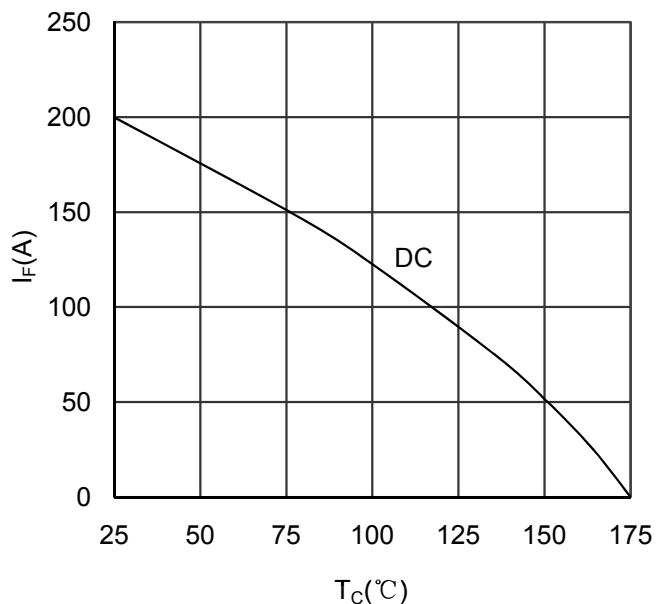

Figure 8. Forward current vs Case temperature Diode(D5, D6)

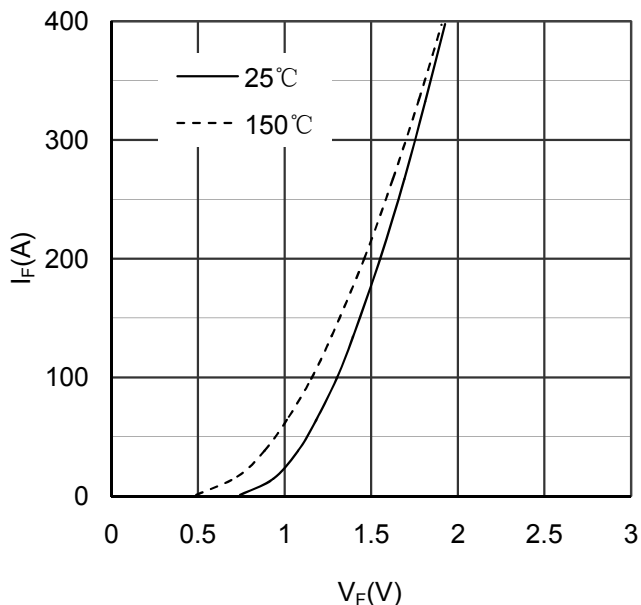

Figure 9. Diode Forward Characteristics Diode(D5, D6)

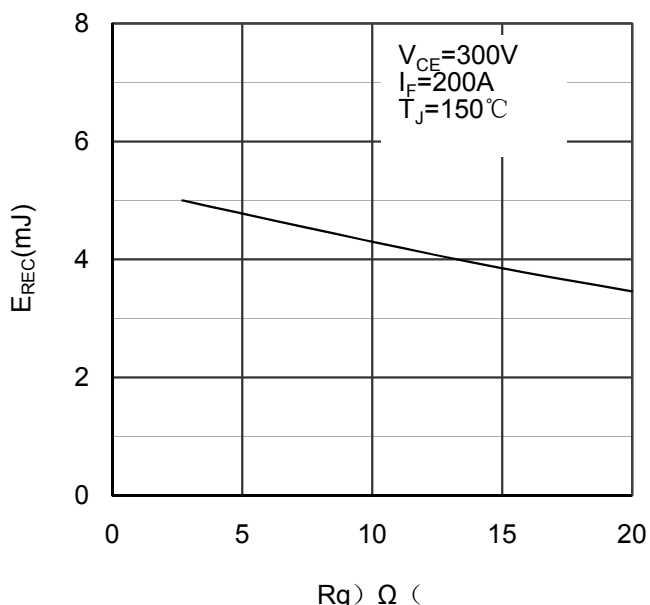

Figure 10. Switching Energy vs Gate Resistor Diode(D5, D6)

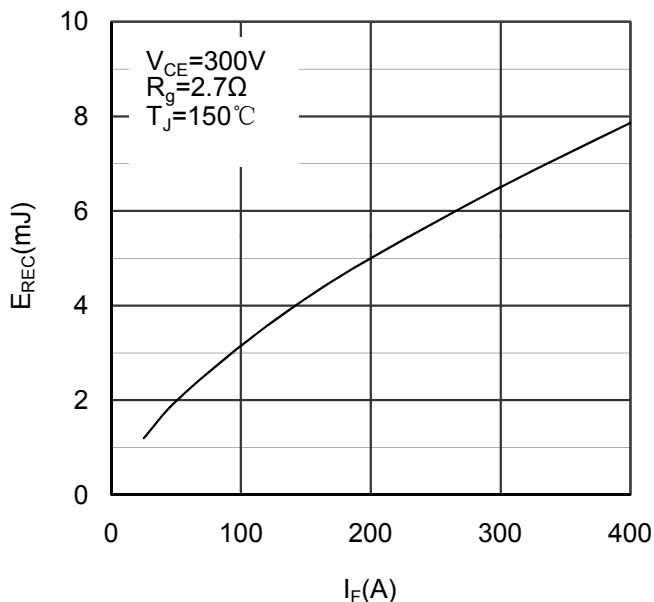

Figure 11. Switching Energy vs Forward Current Diode(D5, D6)

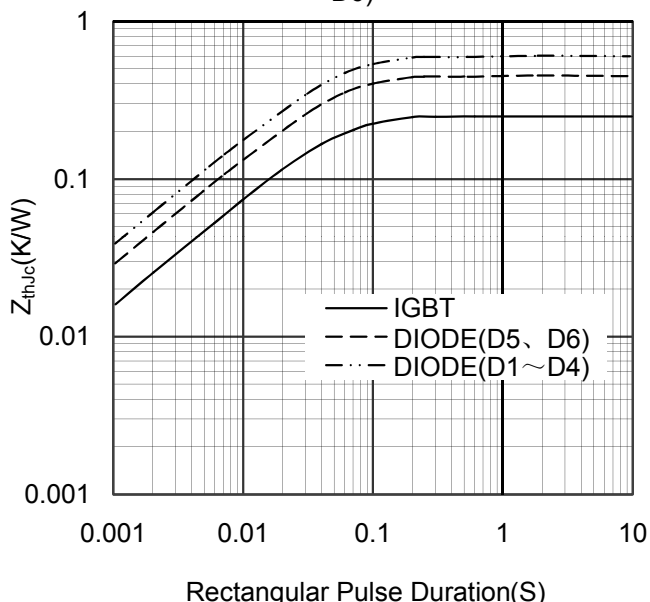

Figure 12. Transient Thermal Impedance of Diode and IGBT

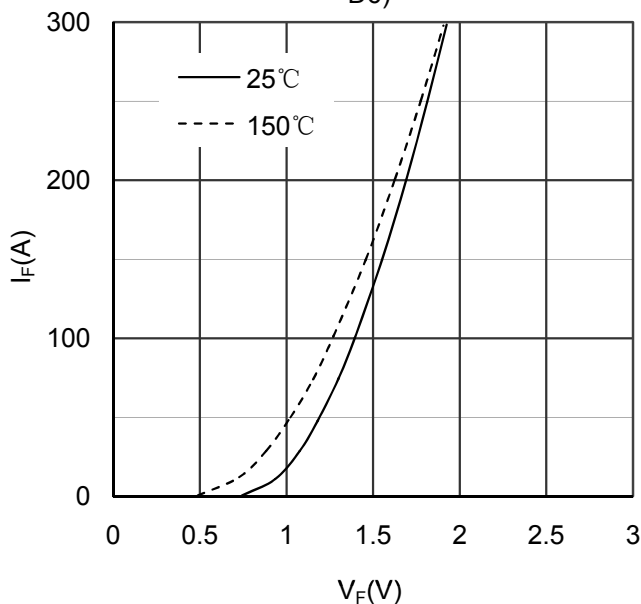

Figure 13. Diode Forward Characteristics Diode(D1~D4)

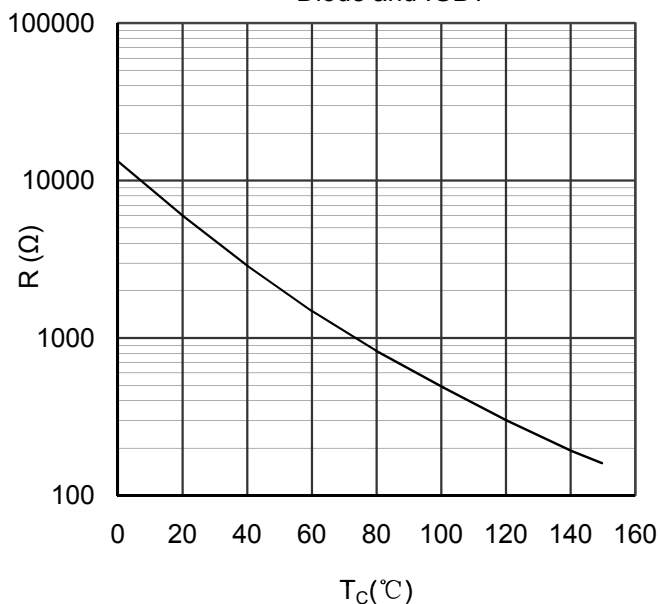

Figure 14. NTC Characteristics

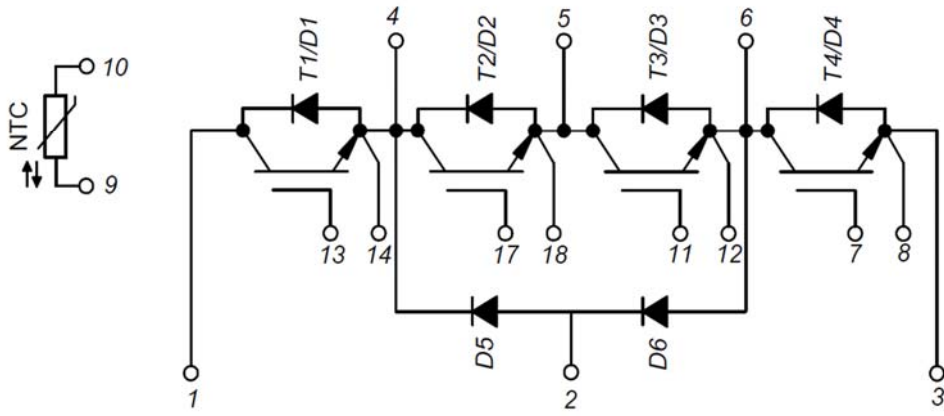
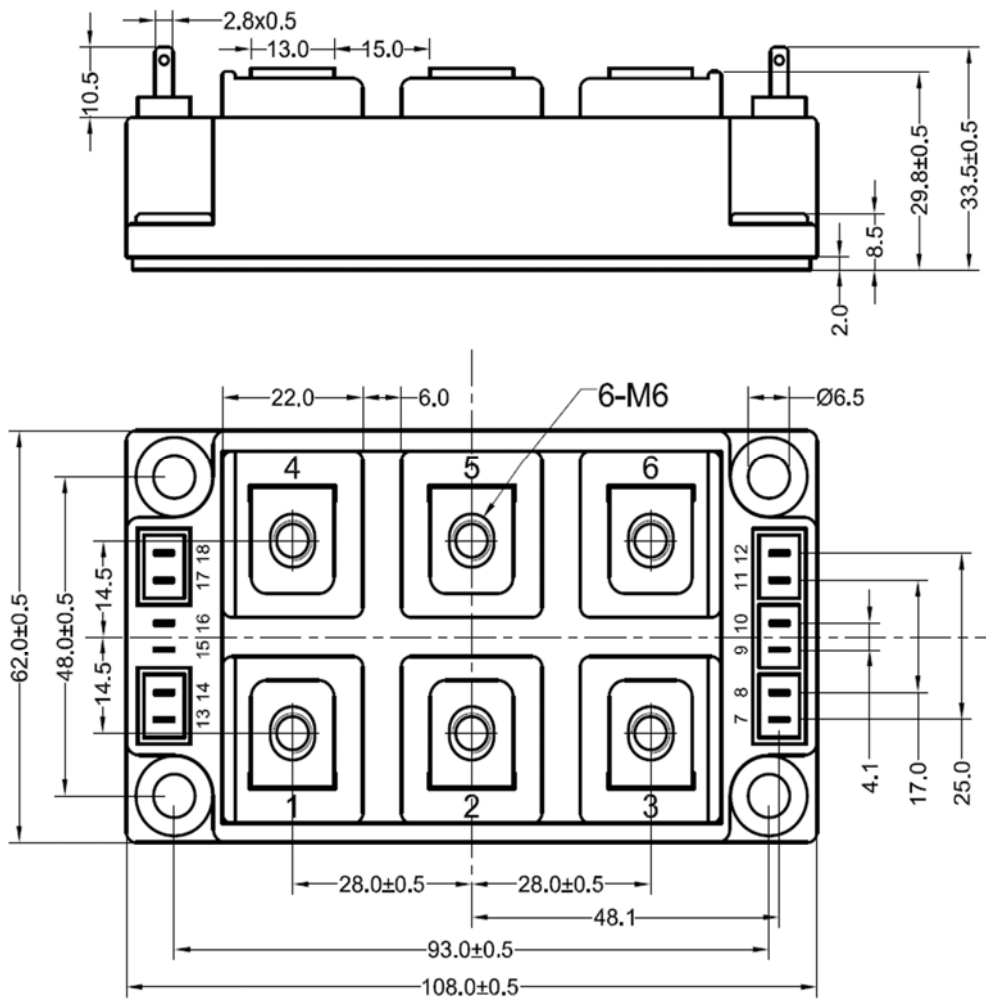

Figure 15. Circuit Diagram



Dimensions in (mm)

Figure 16. Package Outline