

PRODUCT FEATURES

- Proprietary New Trench Technology
- $R_{DS(ON),typ}=7.0m\Omega@V_{GS}=10V$
- Low Gate Charge Minimize Switching Loss
- Fast Recovery body Diode

APPLICATIONS

- High efficiency DC/DC Converters
- Synchronous Rectification
- UPS inverter

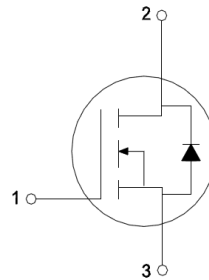

1.GATE
2.DRAIN
3.SOURCE

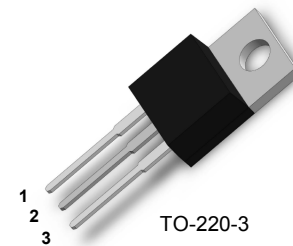

TO-220-3

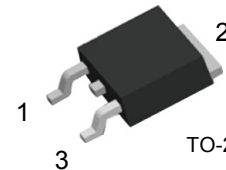

TO-263

Type	V_{DS}	I_D	$R_{DS(ON),max}$ $T_J=25^\circ C$	T_{Jmax}	Marking	Package
MM4410K	100V	99	9.0m Ω	175 $^\circ C$	MM4410K	TO-220
MM4410S	100V	99	9.0m Ω	175 $^\circ C$	MM4410S	TO-263

ABSOLUTE MAXIMUM RATINGS

$T_C=25^\circ C$ unless otherwise specified

Symbol	Parameter/Test Conditions		Values	Unit
V_{DSS}	Drain Source Voltage	$T_J=25^\circ C$	100	V
V_{GSS}	Gate Source Voltage		± 20	
I_D	Continuous Drain Current	$T_C=25^\circ C$ (Silicon limited)	99 ^①	A
		$T_C=100^\circ C$ (Silicon limited)	70	
I_{DM}	Pulsed Drain Current at $V_{GS}=10V$	Limited by T_{Jmax}	443	
P_D	Maximum Power Dissipation		197	W
E_{AS}	Single Pulse Avalanche Energy ($V_{DD}=50V, L=1mH$)		300	mJ
T_{Jmax}	Max. Junction Temperature		175	$^\circ C$
T_{STG}	Storage Temperature Range		-55~175	
Torque	Module to Sink (TO-220)	Recommended (M3)	1.1	Nm
Weight			2.5	g

① Calculated continuous current based on maximum allowable junction temperature. Package limitation current is 80A.

THERMAL CHARACTERISTICS

$T_C=25^\circ C$ unless otherwise specified

Symbol	Parameter/Test Conditions		Values	Unit
R_{thJC}	Thermal resistance, junction to case		0.76	$^\circ C/W$
R_{thJA}	Thermal resistance, junction to ambient		62	

ELECTRICAL CHARACTERISTICS

 $T_C = 25^\circ\text{C}$ unless otherwise specified

Symbol	Parameter/Test Conditions		Min.	Typ.	Max.	Unit
$V_{(BR)DSS}$	Drain Source Breakdown Voltage	$V_{GS}=0V, I_D=250\mu A$	100			V
$R_{DS(ON)}$	Drain Source ON Resistance	$V_{GS}=10V, I_D=58A$		7	9	m Ω
I_{DSS}	Drain Source Leakage Current	$V_{DS}=100V, V_{GS}=0V$			25	μA
$V_{GS(th)}$	Gate Threshold Voltage	$V_{GS}=V_{DS}, I_D=250\mu A$	2.0		4.0	V
I_{GSS}	Gate Leakage Current	$V_{DS}=0V, V_{GS}=\pm 20V$	-100		100	nA
R_{gint}	Integrated Gate Resistor			1.9		Ω
Q_g	Total Gate Charge	$V_{DD}=50V, I_D=58A, V_{GS}=10V$		120		nC
Q_{gs}	Gate Source Charge			30		nC
Q_{gd}	Gate Drain Charge			33		nC
g_{fs}	Forward Transconductance	$V_{DS}=10V, I_D=58A$		TBD		S
C_{iss}	Input Capacitance	$V_{DS}=25V, V_{GS}=0V, f=1\text{MHz}$		4.6		nF
C_{oss}	Output Capacitance			460		pF
C_{rss}	Reverse Transfer Capacitance			240		pF
$t_{d(on)}$	Turn on Delay Time	$V_{DD}=65V, I_D=58A,$ $R_G=2.2\Omega, V_{GS}=10V$	$T_J=25^\circ\text{C}$		45	ns
t_r	Rise Time				95	ns
$t_{d(off)}$	Turn off Delay Time				110	ns
t_f	Fall Time				58	ns

Source-Drain BODY-DIODE CHARACTERISTICS

 $T_C = 25^\circ\text{C}$ unless otherwise specified

Symbol	Parameter/Test Conditions		Min.	Typ.	Max.	Unit
I_{SD}	Continuous Source Drain Current				99	A
I_{SDM}	Pulse Source Drain Current	Limited by T_{Jmax}			443	A
V_{SD}	Forward Voltage	$I_S=58A, V_{GS}=0V$			1.2	V
t_{rr}	Reverse Recovery time	$I_F=58A, V_{GS}=0V$		85		ns
Q_{RR}	Reverse Recovery Charge	$di_F/dt=-100A/\mu s$		160		nC

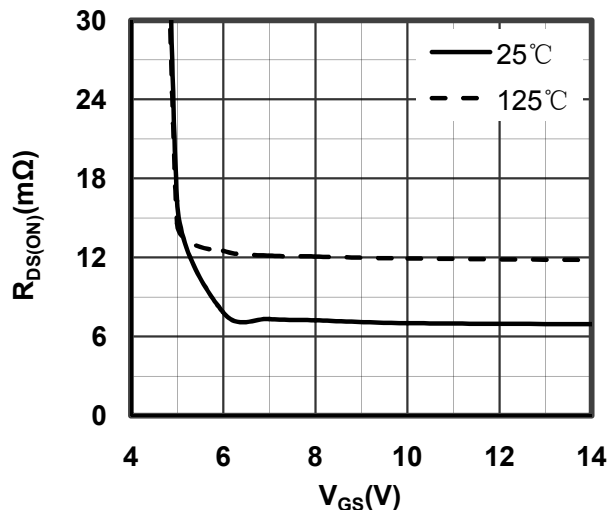

Figure 1. Typical $R_{DS(ON)}$ vs Gate Voltage

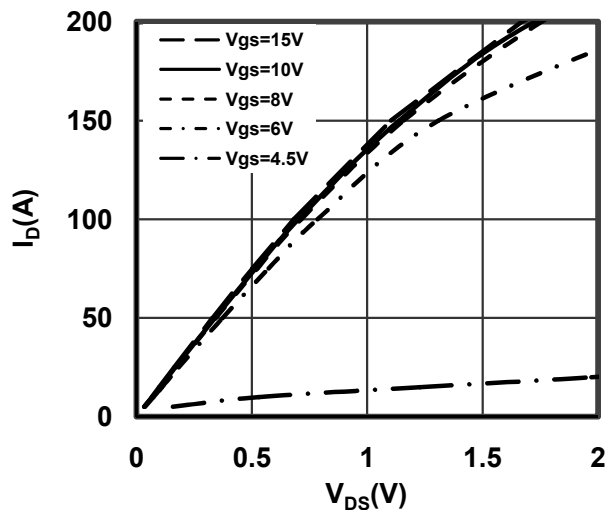

Figure 2. Typical Output Characteristics

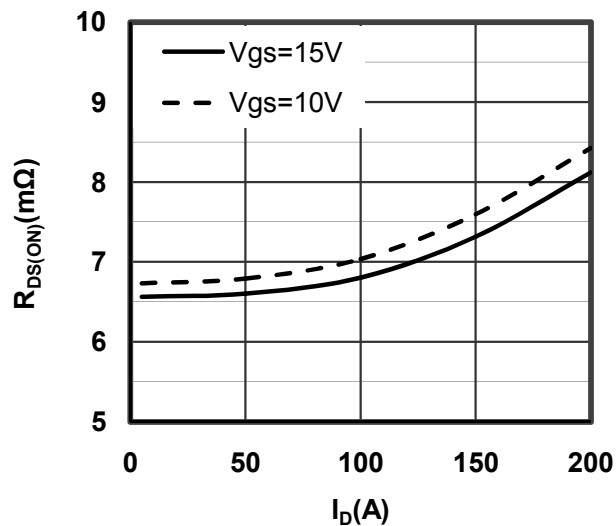

Figure 3. Drain-Source ON Resistance vs I_D

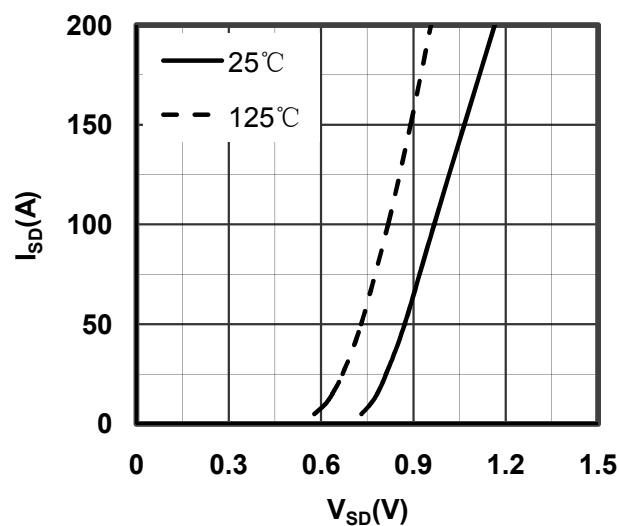

Figure 4. Source-Drain Voltage

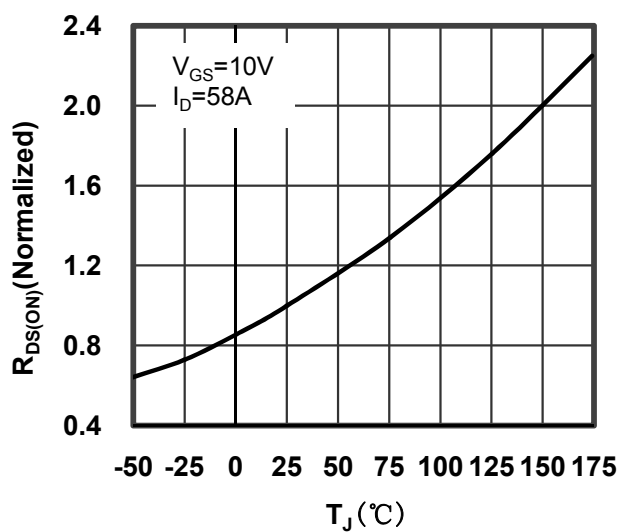

Figure 5. Drain-Source ON Resistance vs Junction Temperature

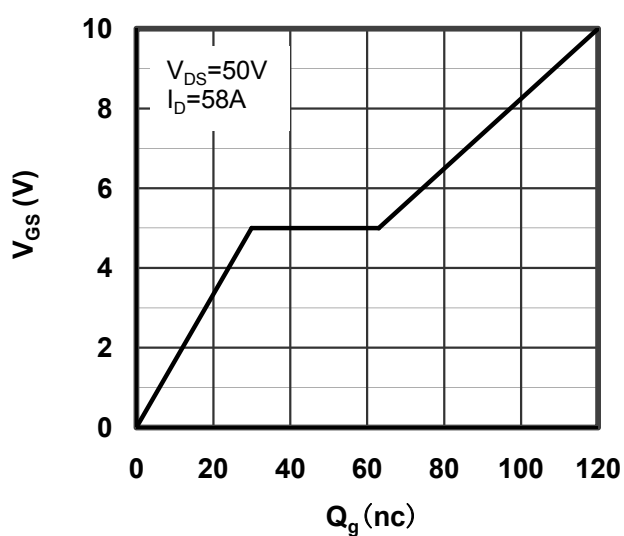

Figure 6. Gate Charge characteristics

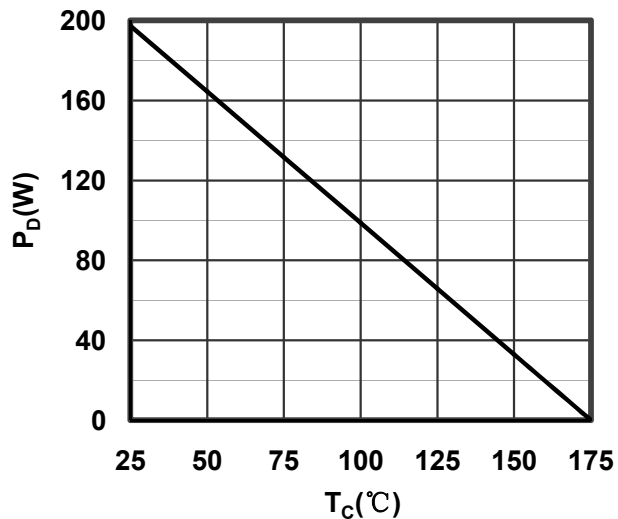

Figure 7. Maximum Power Dissipation vs Case Temperature

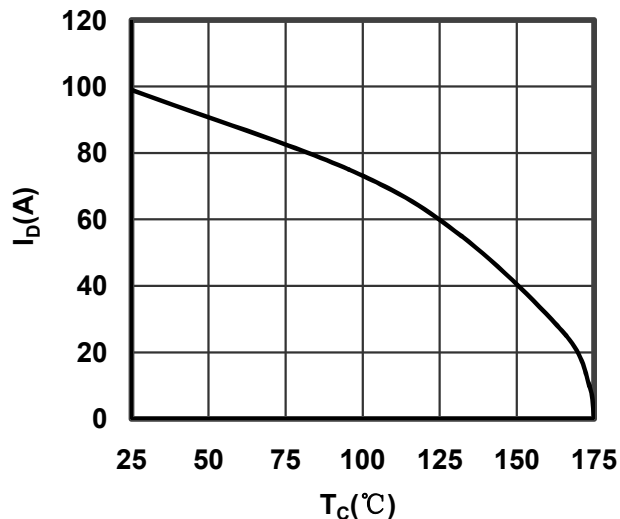

Figure 8. Maximum Continuous Drain Current vs Case Temperature

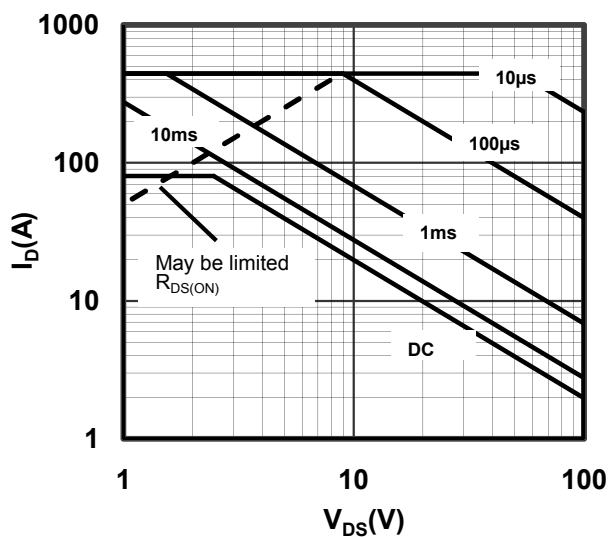

Figure 9. Maximum Forward Safe Operation Area

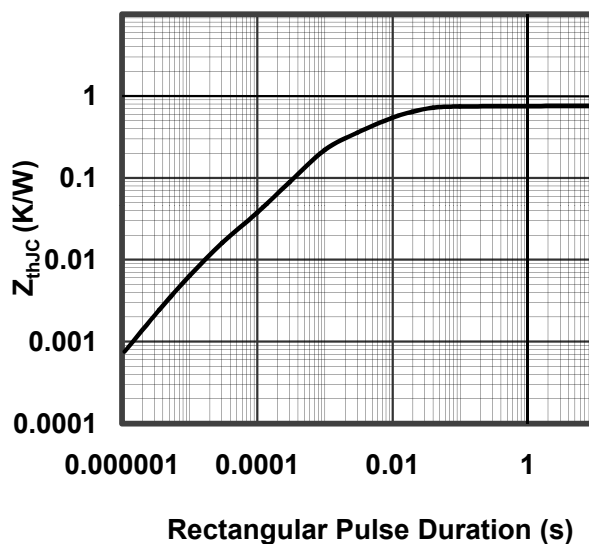
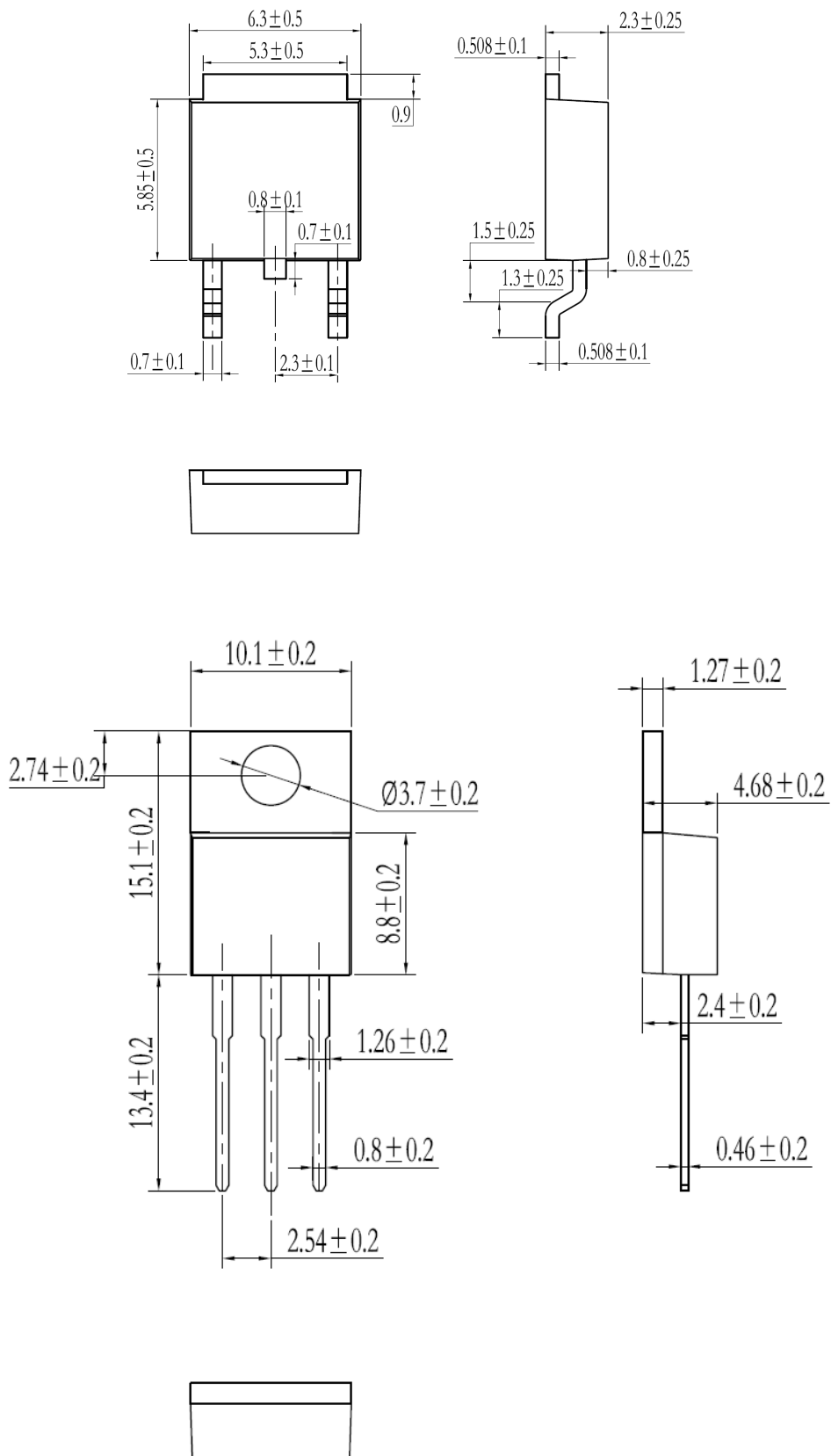

Figure 10. Transient Thermal Impedance



Dimensions in (mm)
Figure 11. Package Outline